



PROJECT INFORMATION – Underwater Car Park Tjuvholmen

Information about the project:

- Car park, prefabricated as large concrete caissons in a dry dock
- Towed to site at Tjuvholmen (Port of Oslo) and installed on piles
- The finished construction consists of four concrete caissons (containing the parking space) and connecting slabs
- The construction forms the foundations for several multi-storey buildings and the surrounding area

Client: Tjuvholmen KS
Contractor: Skanska Norge AS
Consultant (building): Dr. Ing. Aas-Jakobsen AS
Construction time: 2007-2009

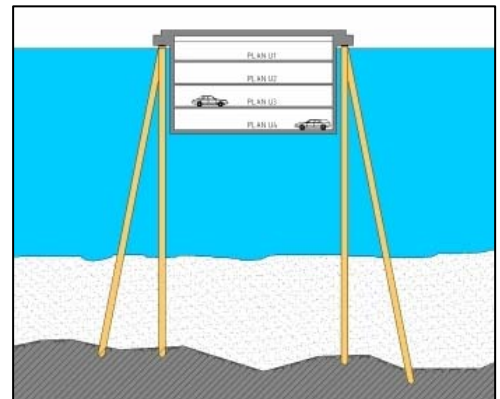

Section showing the concept



Modell of the finished project (source: Skanska)



Tow of a concrete caisson to the site (Photo: Skanska)

HRC-Europe has delivered the following products to the project:

HRC 100 series T-headed reinforcement

HRC 400 series reinforcement couplers



HRC 400



HRC 100

PROJECT INFORMATION – Underwater Car Park Tjuvholmen

Examples for the use of HRC-products:

Supporting corbels for caissons:

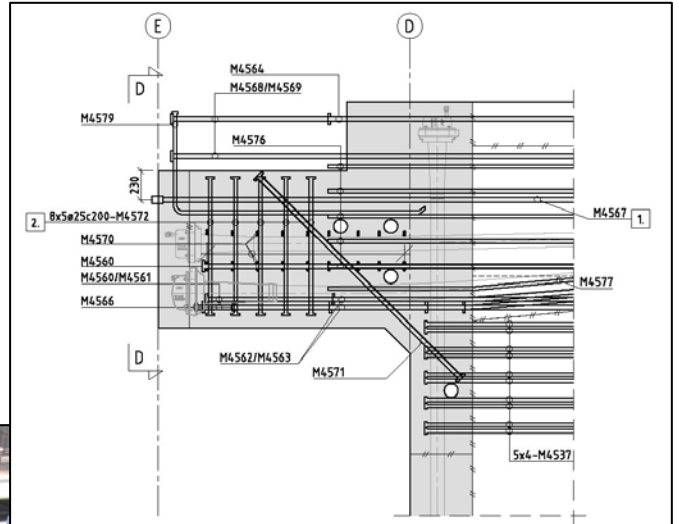
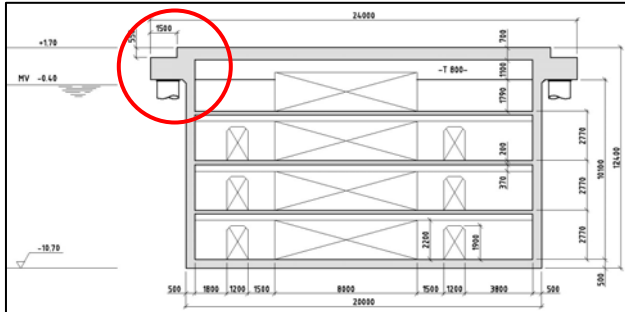

PROJECT INFORMATION – Underwater Car Park Tjuvholmen

Short connection between prefabricated elements / shear reinforcement:

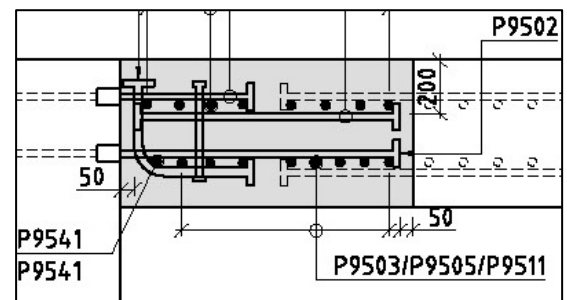
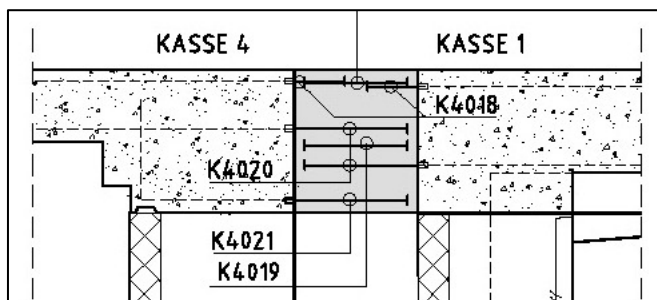
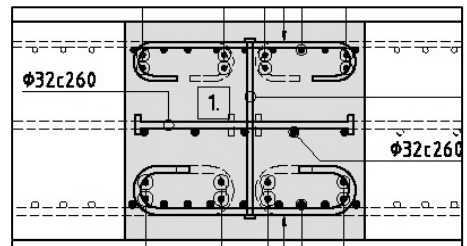
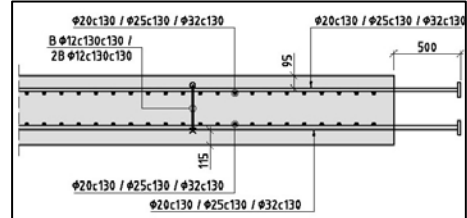

PROJECT INFORMATION – Underwater Car Park Tjuvholmen

Connection between walls and slabs with HRC 400 reinforcement couplers:

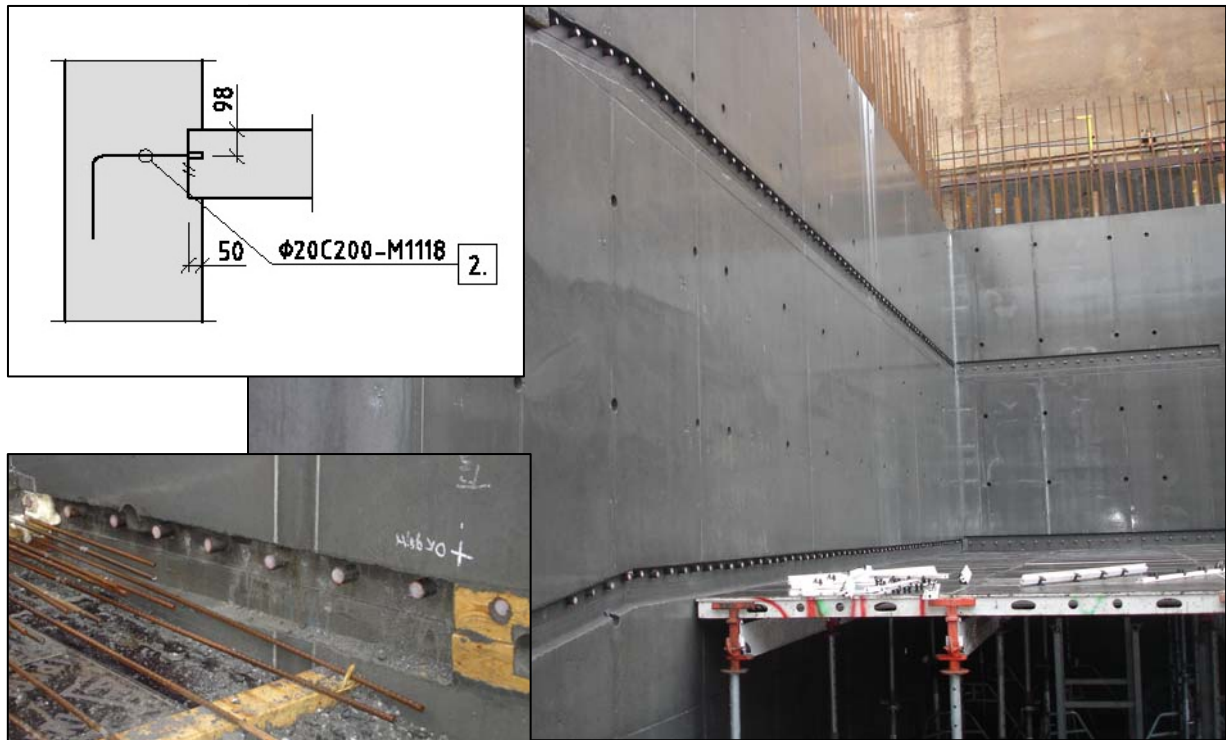

Transversal reinforcement for confinement around prestressing cables:

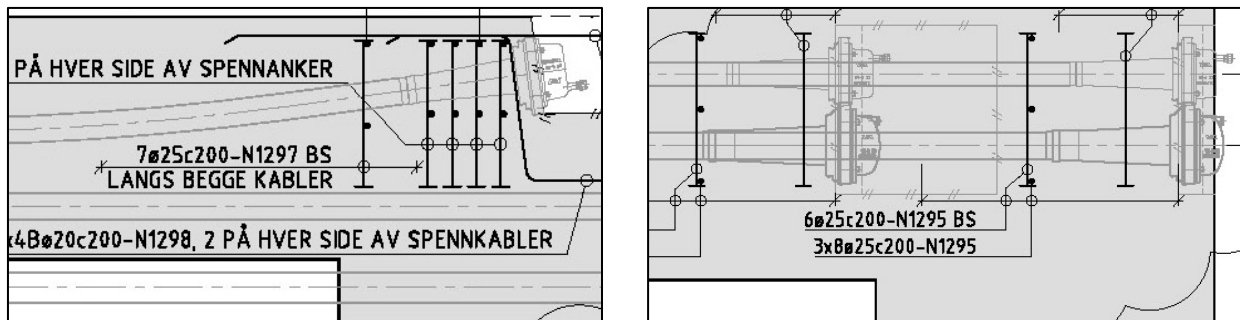

We thank Skanska Norge AS and Dr. Ing Aas-Jakobsen AS for the kind permission to use drawings and photos.